

Data Sheet



Article number: 021816025329

Description: Clamp with bracket and rubber
SPGU 6025. 329/30 SK

Measures

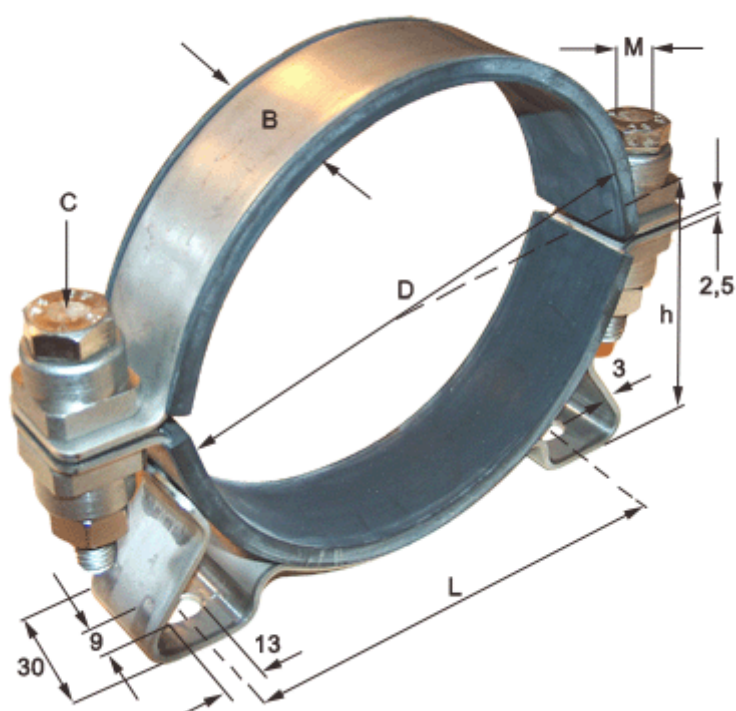

C (screw type) = SK hexagon screw

Diameter D = 329

h = 173

L = 280

Width B = 30